











19 825 809



- Ausladung 241 mm
- schwenkbarer Auslauf 360°
- luftangereicherter Strahl
- Durchfluss max. 7 l/min bei 3 bar Fließdruck
- bleifrei
- Dieses Produkt leistet einen Beitrag zur Erfüllung der Vorgaben von nachhaltigen Gebäudezertifizierungen, z.B. LEED®, BREEM®, DGNB

	Chrom	19 825 809-00
	Platin gebürstet	19 825 809-06
	Platin	19 825 809-08
	Messing (23kt Gold)	19 825 809-09
	Dark Chrome	19 825 809-19
	Messing gebürstet (23kt Gold)	19 825 809-28
	Schwarz matt	19 825 809-33
	Champagne gebürstet (22kt Gold)	19 825 809-46
	Champagne (22kt Gold)	19 825 809-47
	Chrom gebürstet (Edelstahl-Look)	19 825 809-93
	Dark Platinum gebürstet	19 825 809-99

### Empfohlenes Zubehör

VAIA Spender mit Rosette - Chrom 82 434 809-00



19 825 809

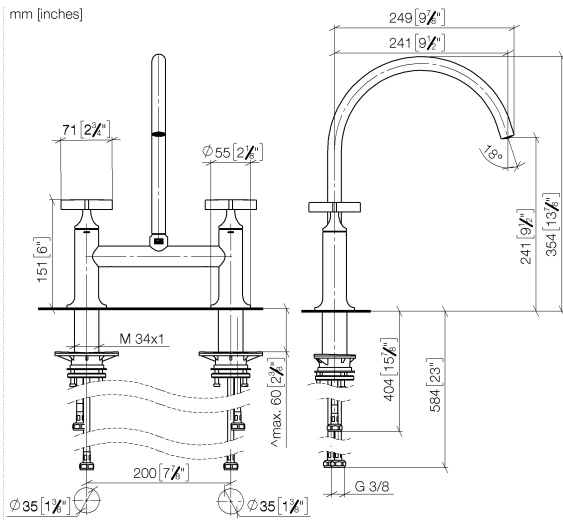

**Durchflussdiagramm**

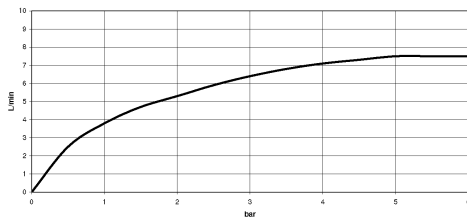

**Zertifikate**

LGA\_38632.

19 825 809

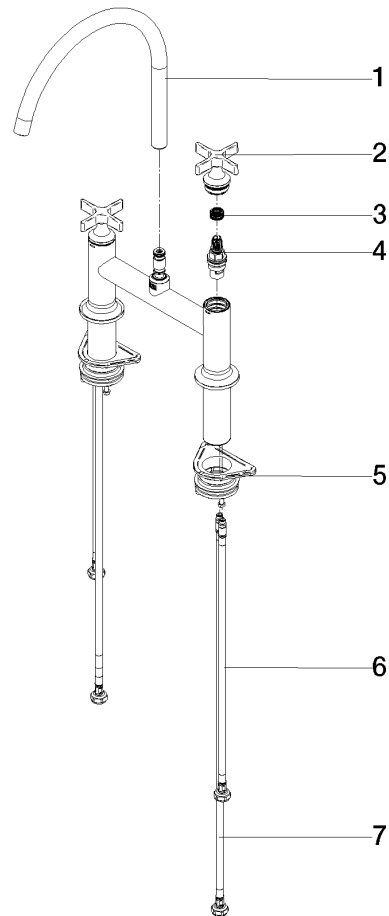

**Ersatzteilstückliste**

Nr.	Artikelnummer	Benennung	Verbaumenge	Lieferzeit
1	90 28 22 396 00-00	Auslauf	1	10
2	90 20 80 036 00-00	Griff	2	-
Ersatzteil nicht mehr bestellbar, bitte bestellen Sie den Nachfolgeartikel				
3	90 12 12 232 00 90	Rastbuchse	2	2
4	90 90 03 131 00 90	Oberteil	2	2
5	04 30 11 040 00 90	Befestigungssatz	2	2
6	04 30 04 100 00 90	Schlauch	2	2
7	04 30 04 101 00 90	Schlauch	2	2